

MODEL# 4950 NEW STYLE

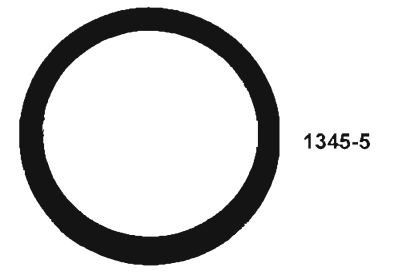
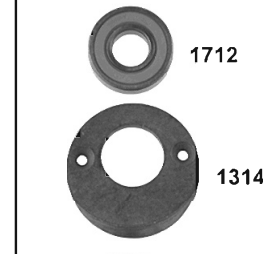
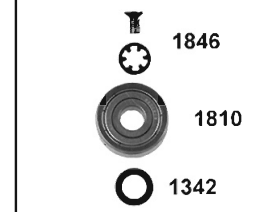
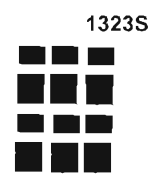
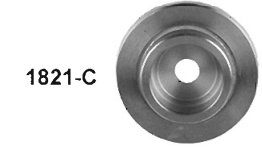
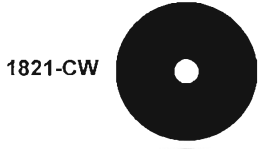
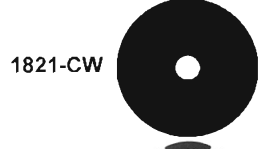
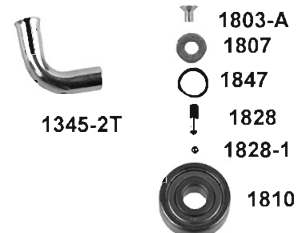
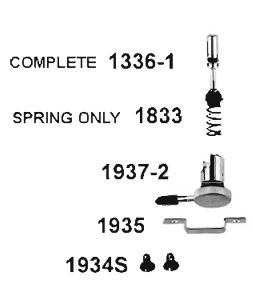
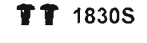
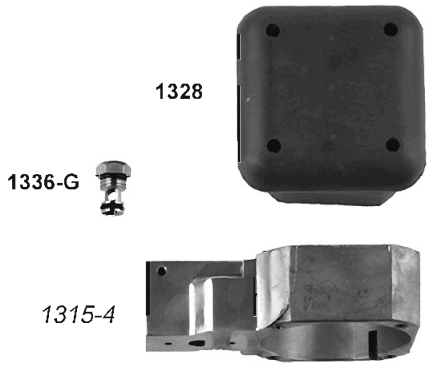

For a complete Parts Description and Price List – [Click Here](#)
 For a complete Pad Reference Sheet – [Click Here](#)
 For a complete Vacuum Connector Sheet – [Click Here](#)