

# MODEL# 3560

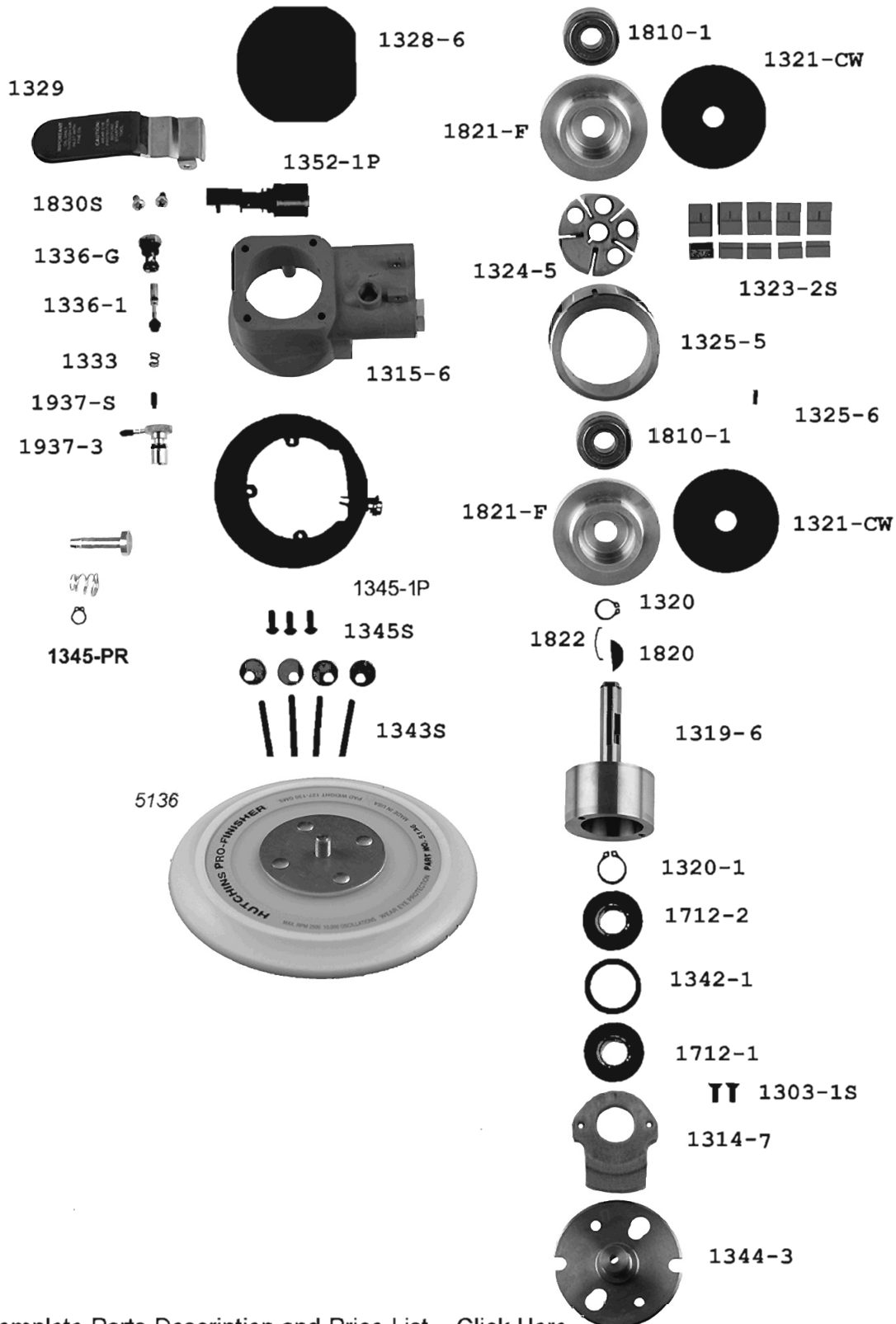

For a complete Parts Description and Price List – [Click Here](#)  
 For a complete Pad Reference Sheet – [Click Here](#)